

HJ 1237 2021

机动车排放定期检验规范

Specification for motor vehicles periodic emissions inspection

2021-12-27

2022-07-01

生态环境部

	ii
1	1
2	1
3	1
4	2
5	3
6	3
7	4
8	4
9	4
A	5
B	11
C	OBD	15
D	17
E	19

OBD

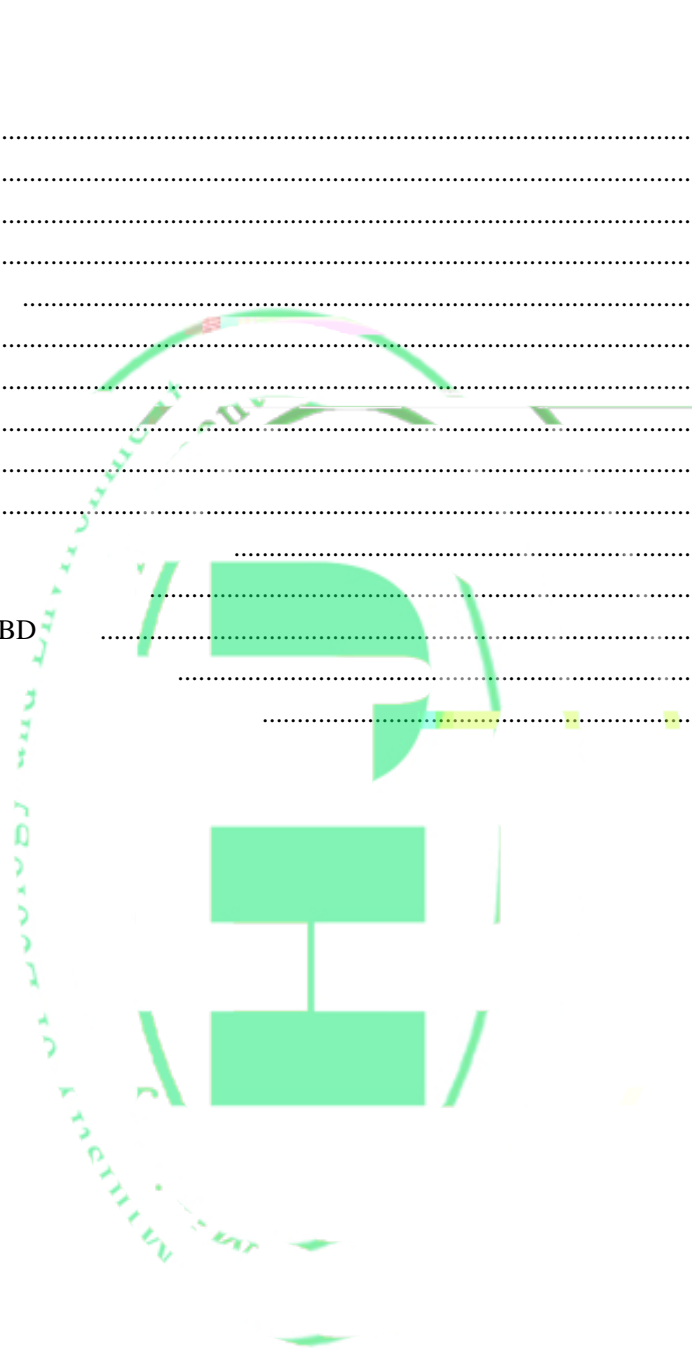

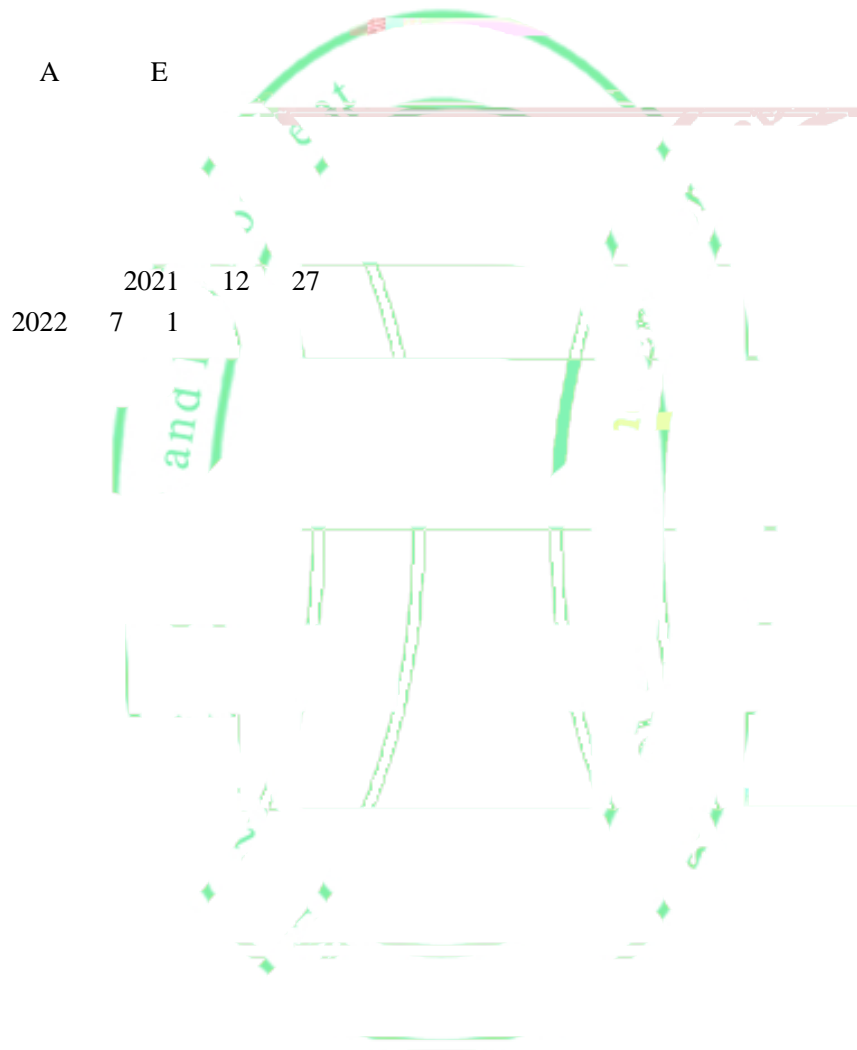

GB 3847				
GB/T 8170				
GB 17691				
GB 18285				
GB 18352				
HJ 1238				
ISO 9141	—			
ISO 13400	—		DoIP	
ISO 14229	—		UDS	
ISO 14230	—	K	DoK-Line	
ISO 15031				
ISO 15765	—	CAN	DoCAN	
ISO 27145				WWH-OBD
SAE J1850	B			
SAE J1939				

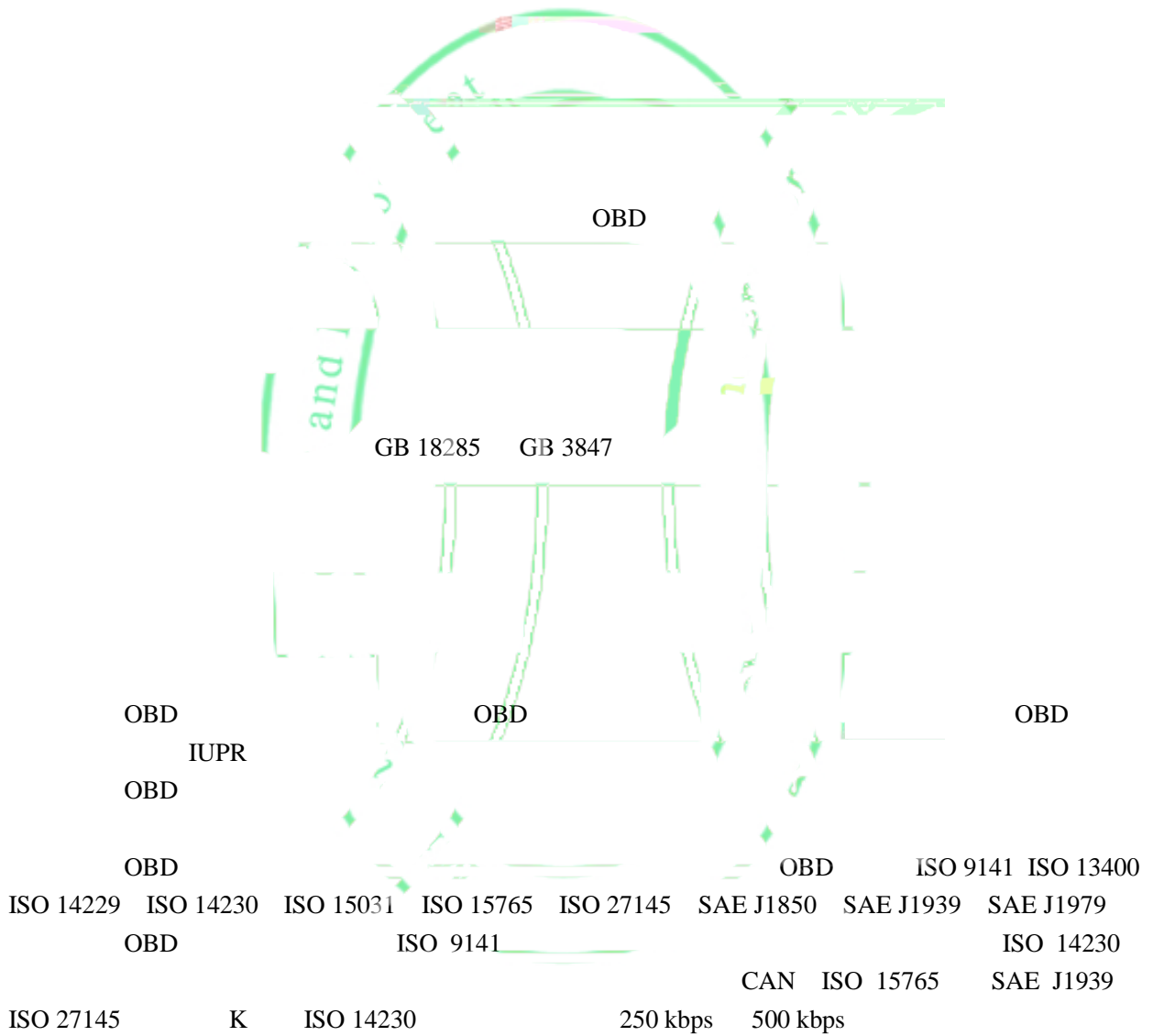

OBD

OBD

a
b
c
d
e

NO

A

7.5 m

3.5 m

GB 18285 GB 3847 HJ 1238

A

HJ 1238

GB 18285 GB 3847

GB 18285 GB 3847

OBD

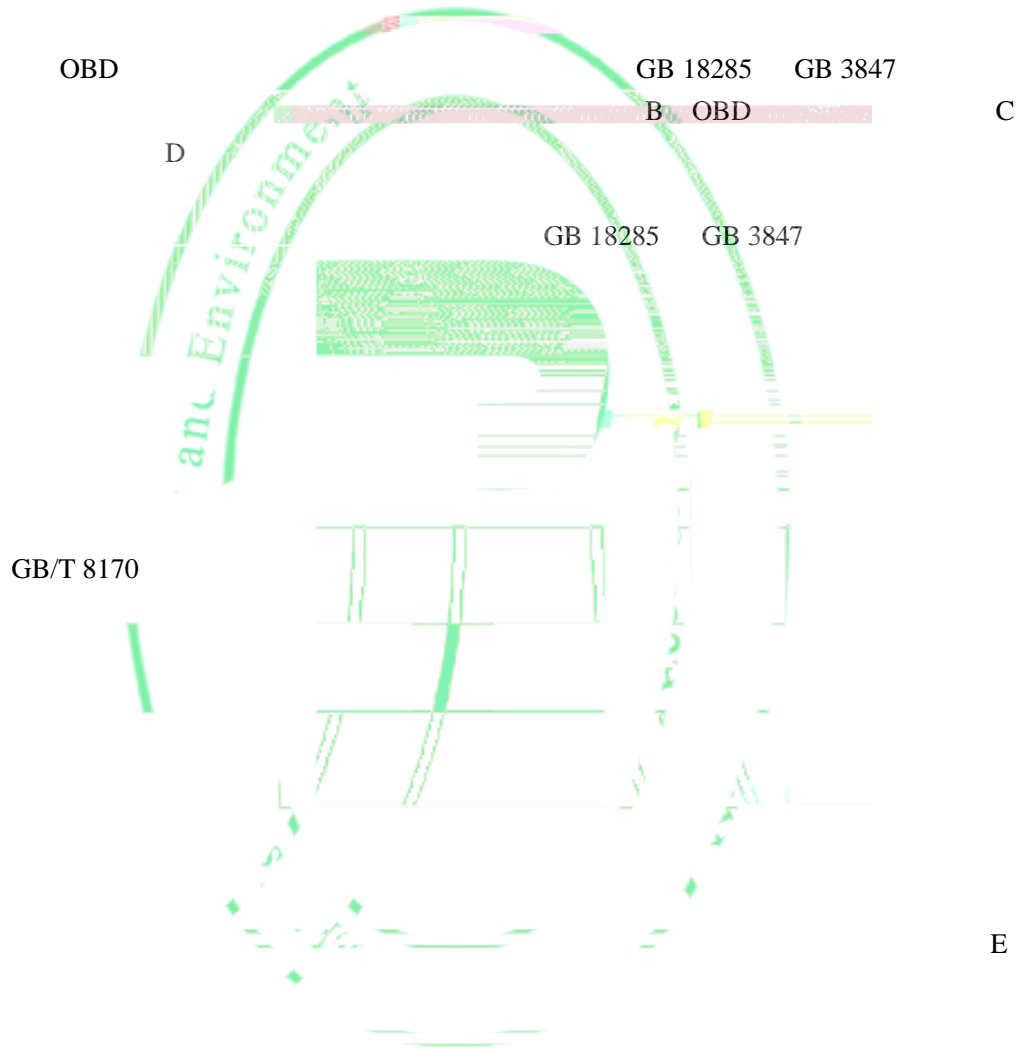

GB 18285 GB 3847

	HC		HC	
		CO	CO ₂ HC O ₂	

		HC CO CO ₂ NO		
		O ₂		
		HC CO NO		
		HC CO NO _x HC		

		CO NO O ₂		
		3		
		50 km/h~30 km/h 35 km/h~15 km/h		
				/
			180	

		HC CO CO ₂ NOx		
		O ₂		
		HC CO NOx		
		HC CO NOx		
		HC		
		CO NOx O ₂		
NOx		NO ₂ NO	NOx	NO
		AA 90%		
		3		
		50 km/h~30 km/h 35 km/h~15 km/h		
				/
			180	

		0% 100%		

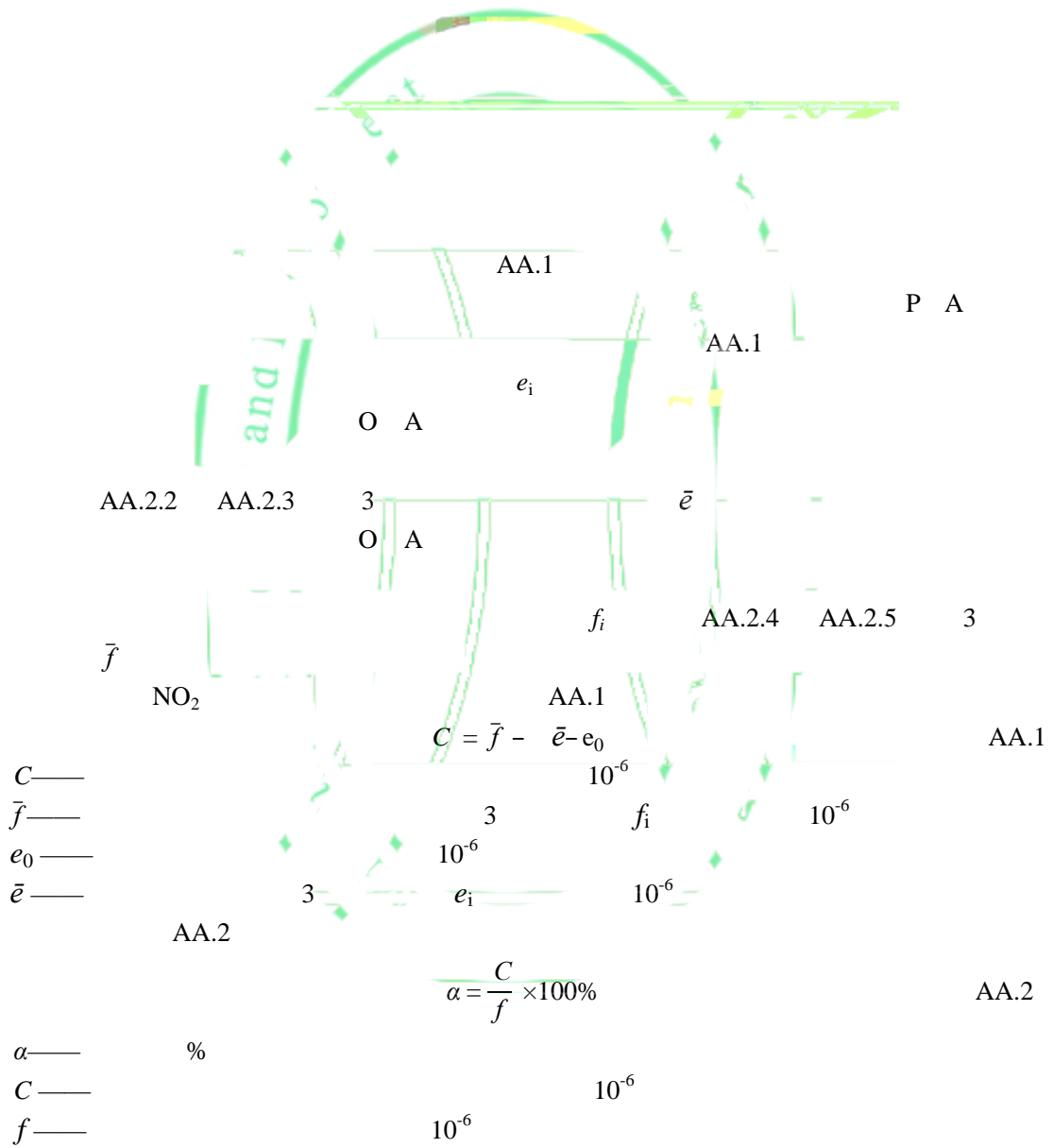

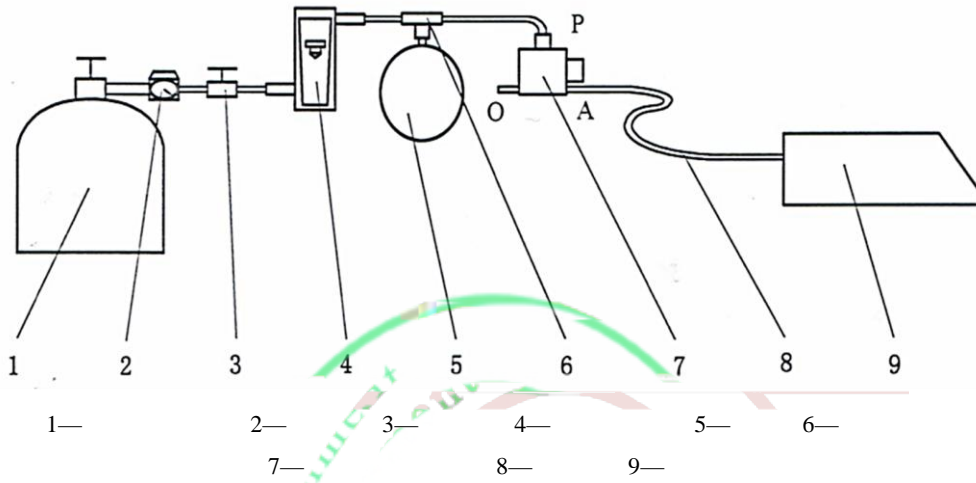

AA.3.9

NO_x

AA.2

AA.3.2

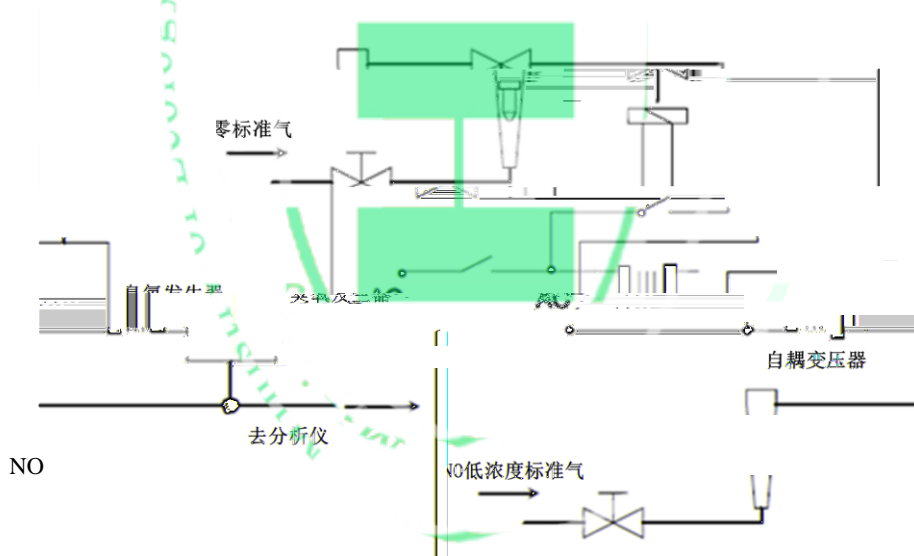

	NO	NO	NO	AA.3.3
T				
10%	c			
		NO	AA.3.3	20%
10%		d		

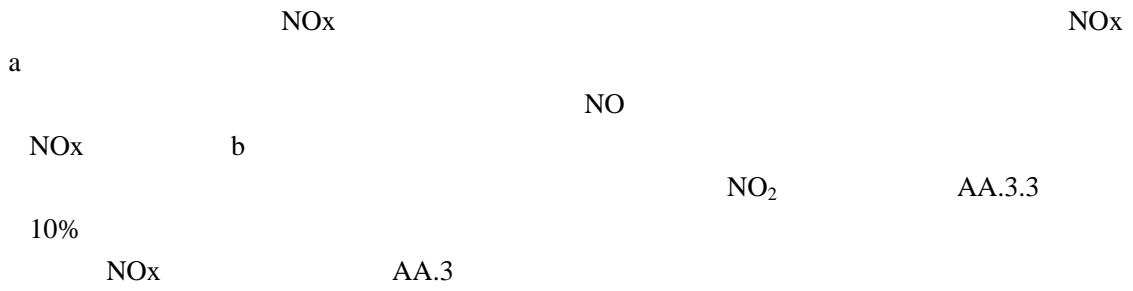

$$\alpha = 1 + \frac{a - b}{c - d} \times 100\%$$

AA.3

- α — %
- a — AA.3.6
- b — AA.3.7
- c — AA.3.4
- d — AA.3.5

NOx	10 ⁻⁶
NOx	10 ⁻⁶
NO	10 ⁻⁶
NO	10 ⁻⁶

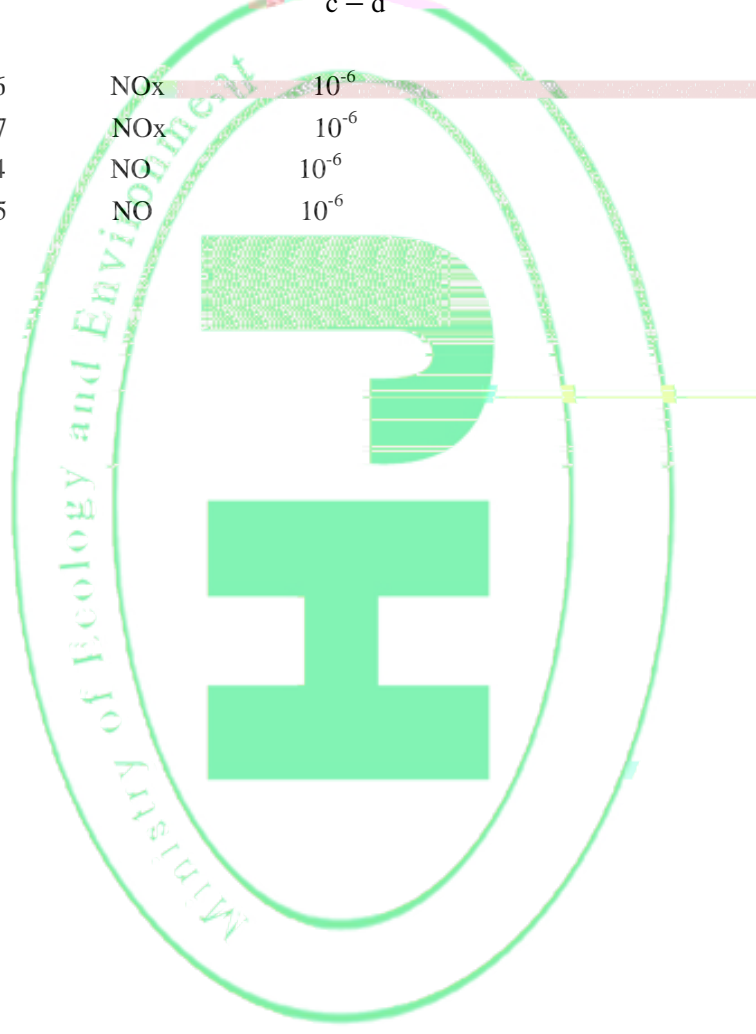

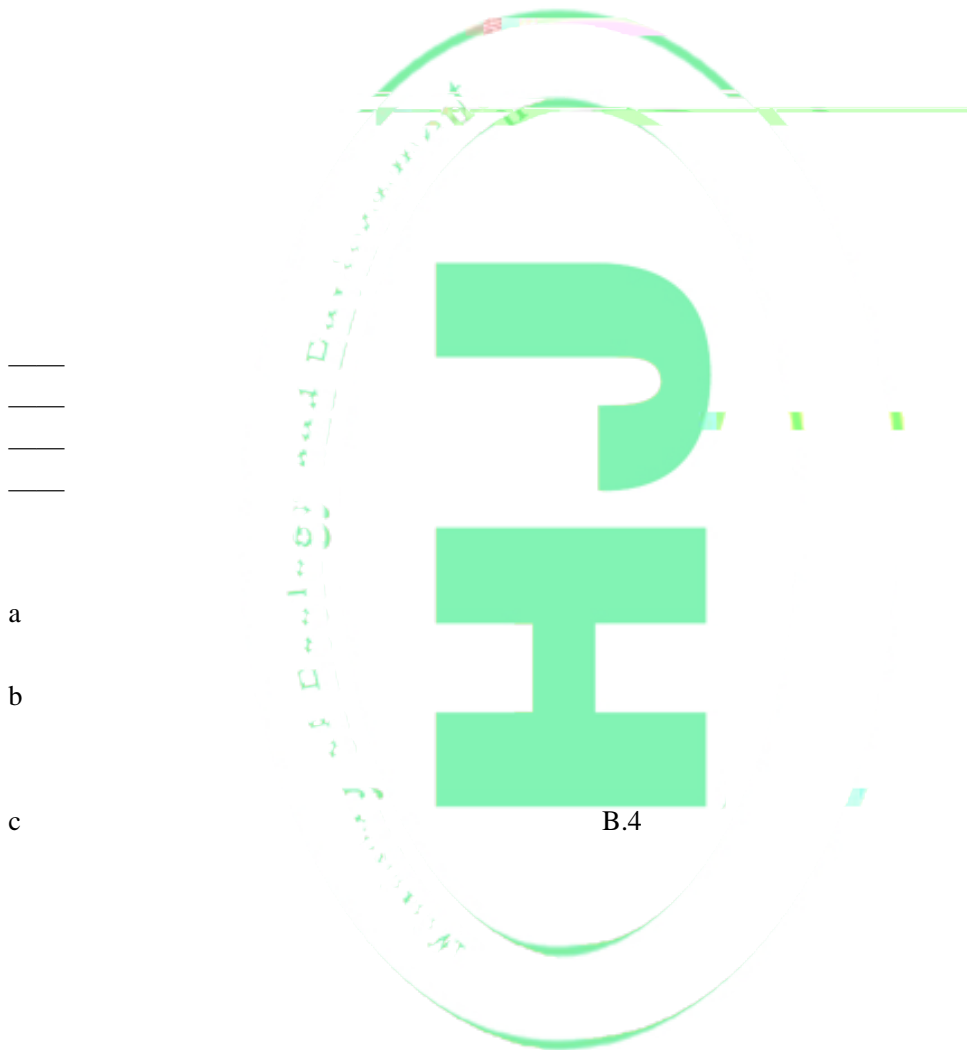

a

b

c

B.4

a

OBD

MI

OBD

b

c

B.4

a

b

c

d

e



1.			
/			
2.			
		VIN	
kg		kg	
		km	
		OBD	
3.			
		L	
kW			
r/min			

4.

	EGR			
	ECU			
	EGR			
	DOC			
	POC			
	SCR			
	ASC			
	DPF			
	6.			
	/x		/x	
		ARS ESP EPC		

OBD

OBD

—OBD
—OBD
— OBD
—OBD

MI

a OBD

OBD

OBD

OBD

b

MI

c

